



OPERATING ROOM

D22/23-1

SKSurgitech™

by Saikang Medical

OPERATING ROOM

www.sksurgitech.com





CONTENTS

- 01 Operating Table
- 15 Obstetric Bed
- 23 LED Operation Lamp
- 39 Medical Bridge, Ceiling Pendant
- 47 Accessories

If the information or specifications are changed without notice, the final signed contract shall prevail.

OPERATING ROOM





A501 Electric-Hydraulic Operating Table

A501 is an advanced, multi-functional electric-hydraulic operating table. Its table top is made of high-strength synthetic board and can transmit X-rays. In addition, the platform can be equipped with a 180° rotation function to realize head and leg interchange, which is applicable for C-arm perspective and placement of some special positions.

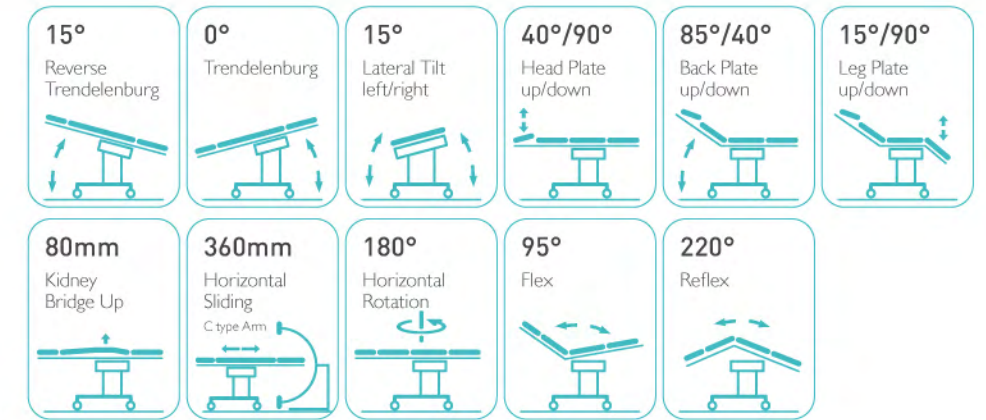

Technical Parameters

External Length	2125mm
External Width	550mm
Table Height Min.	600mm
Table Height Max.	950mm

Technical Configuration

<input checked="" type="checkbox"/> Bed Frame	1pc	<input checked="" type="checkbox"/> Arm Holder with Cushion	2pcs	<input checked="" type="checkbox"/> Kidney Bridge Handle	1pc
<input checked="" type="checkbox"/> Mattress	1 set	<input checked="" type="checkbox"/> Leg Support with Cushion	2pcs		
<input checked="" type="checkbox"/> Anesthesia Screen Frame	1pc	<input checked="" type="checkbox"/> Foot Support with Cushion	2pcs		
<input checked="" type="checkbox"/> Shoulder Holder with Cushion	2pcs	<input checked="" type="checkbox"/> Hand Controller	1pc		



A106-2 Electric-Hydraulic Operating Table

A106-2 is a highly automated electric-hydraulic operating table, which can meet the needs of various surgical operations. The unique design of a super-low position of 500mm, aimed for the brain surgery and ophthalmic surgery.

25° Reverse Trendelenburg 	25° Trendelenburg 	20° Lateral Tilt left/right 	45°/90° Head Plate up/down
80°/20° Back Plate up/down 	15°/90° Leg Plate up/down 	90° Foot Plate Horizontal Positioning 	100mm Kidney Bridge Up



Technical Parameters

External Length	2080mm
External Width	550mm
Table Height Min.	500mm
Table Height Max.	800mm

Technical Configuration

<input checked="" type="checkbox"/> Anaesthesia Screen	1pc	<input checked="" type="checkbox"/> Foot Support	1pc	<input checked="" type="checkbox"/> Fixing Clamp	7pcs
<input checked="" type="checkbox"/> Hand Remote	1pc	<input checked="" type="checkbox"/> Mattress	1set	<input checked="" type="checkbox"/> Power Line	1pc
<input checked="" type="checkbox"/> Kidney Bridge Handle	1pc	<input checked="" type="checkbox"/> Shoulder Support	1pair		
<input checked="" type="checkbox"/> Arm Support	1pc	<input checked="" type="checkbox"/> Long Fixing Clamp	1pair		



A302 Electric Operating Table

A302 is a highly automated electric Multi-functional operating table. Its elevation, lowering, trendelenburg, reverse trendelenburg, lateral tilt, back folding, vertical translation and leg folding are all electrically operated. The operating table is equipped with a digital display hand controller to make operation easy and intuitive. With Imported large diameter castors, smooth movement, stable brake system. The standard dual control system guarantees the safety of operation.

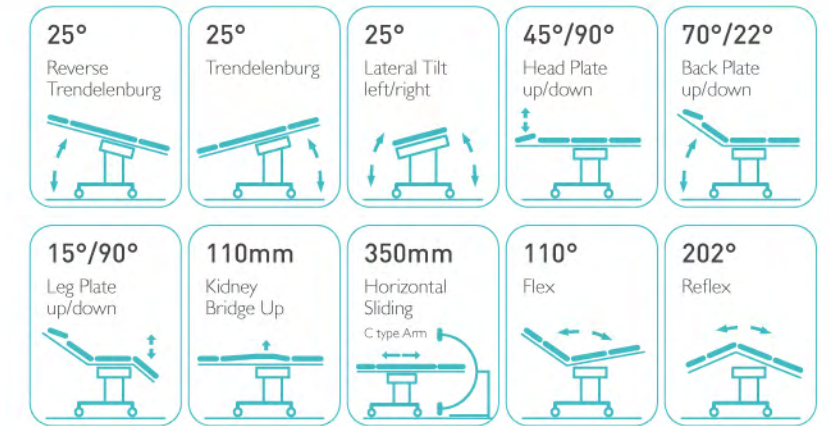

Material

The base material for the table is high thickness 304 stainless steel, seamless welding by robot, with modern appearance and more stable.



Mattress

Polyurethane foam mattress, waterproof and seamless, avoid liquid in. The connection between table and mattress is buckle joint, easy to disassemble and install, easy to clean.



Head Plate

Foldable head plate, support for more type of surgical operations.



Leg Plate

The up and down folding actions of the leg plate are all completed by electric. The leg plate is removable, effortless and smooth.



Hand Controller

All functions controlled by both hand controller or control panel on table base column. With position LCD display on hand controller, easy to operate.



Battery Could Support

Battery could support about 80-120 complete operation cycles. Working time could be last for one week according to usage and help to keep the operating table running in the event of power failure.

Technical Parameters

External Length	2150mm
External Width	555mm
Table Height Min.	700mm
Table Height Max.	1000mm

Technical Configuration

<input checked="" type="checkbox"/> Bed Frame	1 pc	<input checked="" type="checkbox"/> Arm Holder	2 pcs	<input checked="" type="checkbox"/> Sliding Block	8 pcs
<input checked="" type="checkbox"/> Mattress	1 set	<input checked="" type="checkbox"/> Leg Support	2 pcs	<input checked="" type="checkbox"/> Spanner	5 pcs
<input checked="" type="checkbox"/> Anesthesia Screen Frame	1 pc	<input checked="" type="checkbox"/> Foot Support	2 pcs		
<input checked="" type="checkbox"/> Shoulder Holder	2 pcs	<input checked="" type="checkbox"/> Hand Controller	1 pc		

A301

Electric Operating Table

A301 is a multi-functional electric operating table. Its mattress is made of polyurethane molded material, can be sterilized and cleaned at high temperature, and there are no gaps so to avoid bacterial growth. The platform is made of high-purity phenolic resin board applicable for C-arm, and can be slid up to 350mm in one direction. The X-ray photography can carry out the whole body radiography examination without moving the patient, no blind spots or shadows.



Technical Parameters

External Length	2150mm
External Width	555mm
Table Height Min.	750mm
Table Height Max.	1000mm

Technical Configuration

<input checked="" type="checkbox"/> Bed Frame	1pc	<input checked="" type="checkbox"/> Arm Holder	2pcs	<input checked="" type="checkbox"/> Sliding Block	8pcs
<input checked="" type="checkbox"/> Mattress	1set	<input checked="" type="checkbox"/> Leg Support	2pcs	<input checked="" type="checkbox"/> Spanner	5pcs
<input checked="" type="checkbox"/> Anesthesia Screen Frame	1pc	<input checked="" type="checkbox"/> Foot Support	2pcs		
<input checked="" type="checkbox"/> Shoulder Holder	2pcs	<input checked="" type="checkbox"/> Hand Controller	1pc		

A100-4

Electric Operation Table

A100-4 is an electric operating table that can meet the needs of various surgeries. It is driven by low-voltage DC motor, with safe and stable performance. Super wide table top, super long sliding distance. It can be applicable for C-arm. It has a high level of automation, low noise, strong reliability, and imported original parts for key parts. It is a perfect and ideal operating table.



Technical Parameters

External Length	2070mm
External Width	550mm
Table Height Min.	700mm
Table Height Max.	1000mm

Technical Configuration

<input checked="" type="checkbox"/> Bed Frame	1pc	<input checked="" type="checkbox"/> Arm Holder with Cushion	2pcs
<input checked="" type="checkbox"/> Mattress	1set	<input checked="" type="checkbox"/> Leg Support with Cushion	2pcs
<input checked="" type="checkbox"/> Anesthesia Screen Frame	1pc	<input checked="" type="checkbox"/> Foot Support with Cushion	2pcs
<input checked="" type="checkbox"/> Shoulder Holder with Cushion	2pcs	<input checked="" type="checkbox"/> Kidney Bridge Handle	1pc

A100-4A Electric Operating Table

A100-4A is an electric operating table with super load-bearing and extra-long sliding distance, which can be applicable for C-arm. The built-in large-capacity battery can continue to support all operations in the event of a power failure. And the operating table adopts a dual-control system to ensure the safety of the operation.



Technical Parameters

External Length	2100mm
External Width	550mm
Table Height Min.	700mm
Table Height Max.	1000mm

Technical Configuration

<input checked="" type="checkbox"/> Bed Frame	1pc	<input checked="" type="checkbox"/> Arm Holder with Cushion	2pcs	<input checked="" type="checkbox"/> Kidney Bridge Handle	1pc
<input checked="" type="checkbox"/> Mattress	1set	<input checked="" type="checkbox"/> Leg Support with Cushion	2pcs		
<input checked="" type="checkbox"/> Anesthesia Screen Frame	1pc	<input checked="" type="checkbox"/> Foot Support with Cushion	2pcs		
<input checked="" type="checkbox"/> Shoulder Holder with Cushion	2pcs	<input checked="" type="checkbox"/> Hand Controller	1pc		

A2000 Electric Operating Table

A2000 is a basic electric operating table with a very high cost effective, it can fulfill the requirement of general surgeries. Its built-in battery can continue to support all operations in the event of a power failure.

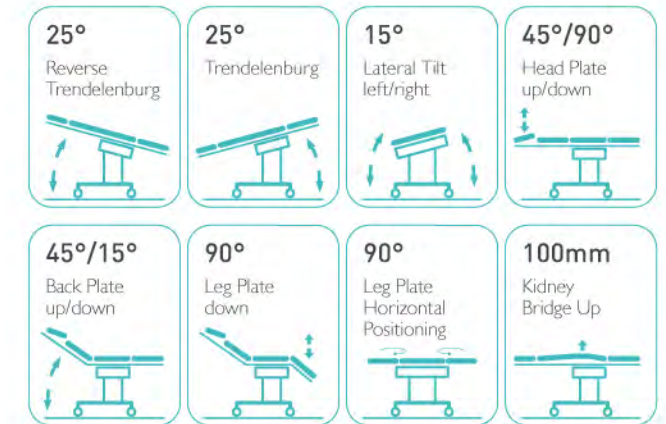

Technical Parameters

External Length	2100mm
External Width	480mm
Table Height Min.	680mm
Table Height Max.	930mm

Technical Configuration

<input checked="" type="checkbox"/> Bed Frame	1pc	<input checked="" type="checkbox"/> Arm Holder	2pcs	<input checked="" type="checkbox"/> Sliding Block	10pcs
<input checked="" type="checkbox"/> Mattress	1set	<input checked="" type="checkbox"/> Leg Support	2pcs	<input checked="" type="checkbox"/> Spanner	4pcs
<input checked="" type="checkbox"/> Anesthesia Screen Frame	1pc	<input checked="" type="checkbox"/> Foot Support	2pcs		
<input checked="" type="checkbox"/> Shoulder Holder	2pcs	<input checked="" type="checkbox"/> Hand Controller	1pc		

A205

Manual Operating Table

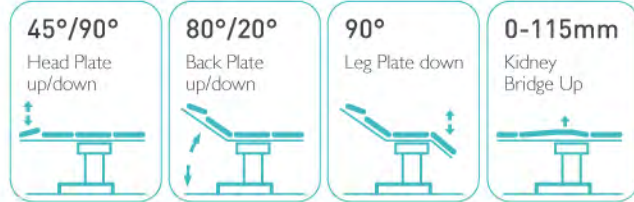

Technical Parameters

External Length	2000mm
External Width	480mm
Table Height Min.	720mm
Table Height Max.	960mm

Technical Configuration

<input checked="" type="checkbox"/> Arm support	2 pcs	<input checked="" type="checkbox"/> Anaesthetic Screen	1 pc
<input checked="" type="checkbox"/> Leg support	2 pcs		
<input checked="" type="checkbox"/> Body Support	2 pcs		
<input checked="" type="checkbox"/> Shoulder Support	2 pcs		

A3001

Manual Operating Table



Technical Parameters

External Length	2000mm
External Width	480mm
Table Height Min.	790mm
Table Height Max.	1040mm

Technical Configuration

<input checked="" type="checkbox"/> Anesthesia Screen Frame	1 pc	<input checked="" type="checkbox"/> Leg Support with Cushion	2 pcs
<input checked="" type="checkbox"/> Mattress	1 set	<input checked="" type="checkbox"/> Shoulder Support with Cushion	2 pcs
<input checked="" type="checkbox"/> Kidney Bridge Handle	1 pc	<input checked="" type="checkbox"/> Body Support with Cushion	2 pcs
<input checked="" type="checkbox"/> Arm Support with Cushion	2 pcs		



A99-7 Electric Obstetric Bed

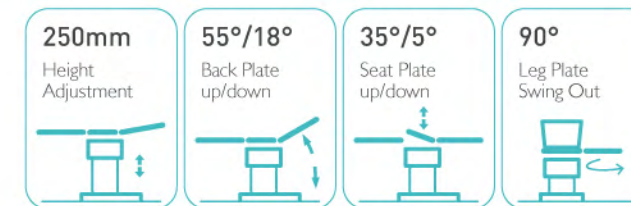

ELECTRIC OBSTETRIC BED

Frame
Base cover made of high quality ABS. It can be sterilized at the temperature above 100 °C. The tensile strength up to 30 MPa. Base structure is made of high-quality seamless steel, robot welded with high strength.

Battery
Battery could support about 80-120 complete operation cycles. Working time could be last for one week according to useage and help to keep the operating table running in the event of power failure.



Bed Width
Seamless foam mattress, with waterproof PU cover. Easy cleaning and disinfection.



Arm Plate
Flexible arm plate adjustment.



Hand Controller
Electrical braking system. Controlled by hand controller.

Technical Parameters

External Length	1980mm
External Width	720mm
Table Height Min.	630mm
Table Height Max.	880mm

Technical Configuration

<input checked="" type="checkbox"/> Bed Frame	1pc	<input checked="" type="checkbox"/> Hand Bars	2pcs	<input checked="" type="checkbox"/> Caster	1pc
<input checked="" type="checkbox"/> Foot Pedal	1pc	<input checked="" type="checkbox"/> Leg Support with Cushion	2pcs		
<input checked="" type="checkbox"/> Hand Controller	1pc	<input checked="" type="checkbox"/> Arm Support with Cushion	2pcs		
<input checked="" type="checkbox"/> Anesthesia Screen	1pc	<input checked="" type="checkbox"/> Stainless Steel Basin	1pc		



A99-13 Electric Obstetric Bed

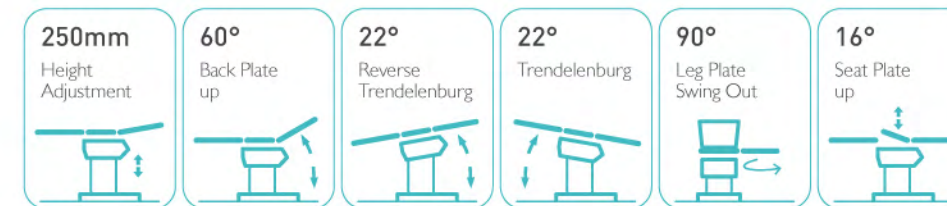

Material
Base structure is made of high-quality 304 stainless steel, robot welded with high strength and modern appearance.



Mattress
Polyurethane foam mattress, waterproof and seamless, easy cleaning and disinfection.



LED Examination Light
Standard accessory. More convenient to do gynecological examination.

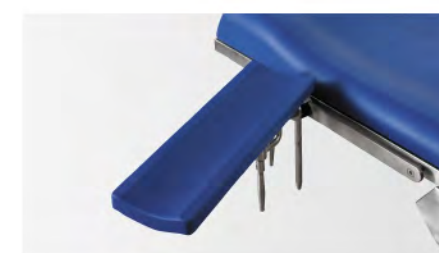

Arm Plate
Flexible arm plate adjustment.



Battery Could Support
Battery could support about 80-120 complete operation cycles. Working time could be last for one week according to useage and help to keep the operating table running in the event of power failure.



Auxiliary plate
Auxiliary plate is easy for rotating and dismantling. Rotating angle: 90°.

Technical Parameters

External Length	2100mm
External Width	600mm
Table Height Min.	750mm
Table Height Max.	1000mm

Technical Configuration

<input checked="" type="checkbox"/> Armrest	2pcs	<input checked="" type="checkbox"/> SST Rinsing Basin	1pc
<input checked="" type="checkbox"/> Knee Curtch	2pcs	<input checked="" type="checkbox"/> Pedal Controller	1pc
<input checked="" type="checkbox"/> Pull Handle	2pcs	<input checked="" type="checkbox"/> LED Examination Light	1pc
<input checked="" type="checkbox"/> Anesthesia Frame	1pc		

A99-5

Electric Obstetric Bed

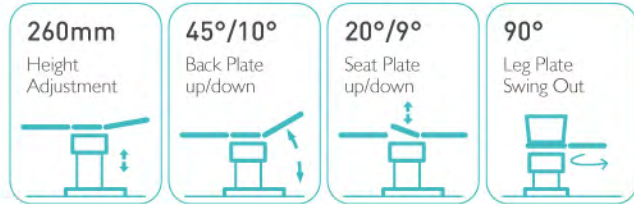

Technical Parameters

External Length	1880mm
External Width	660mm
Table Height Min.	680mm
Table Height Max.	940mm

Technical Configuration

<input checked="" type="checkbox"/> Arm Support	2pcs	<input checked="" type="checkbox"/> Tightener	2pcs	<input checked="" type="checkbox"/> Slider	4pcs
<input checked="" type="checkbox"/> Handle	2pcs	<input checked="" type="checkbox"/> Hand Controller	1pc		
<input checked="" type="checkbox"/> Leg Support	2pcs	<input checked="" type="checkbox"/> Foot Switch	1pc		
<input checked="" type="checkbox"/> Stirrup	2pcs	<input checked="" type="checkbox"/> Stainless Steel Basin	1pc		

A105

Manual Obstetric Table

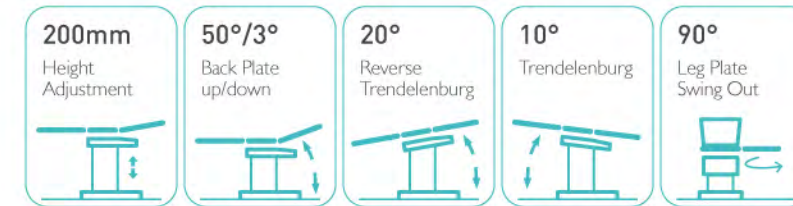

Technical Parameters

External Length	1900mm
External Width	600mm
Table Height Min.	700mm
Table Height Max.	900mm

Technical Configuration

<input checked="" type="checkbox"/> Bed Frame	1pc	<input checked="" type="checkbox"/> Leg Support with Cushion	2pcs
<input checked="" type="checkbox"/> Mattress	1pc	<input checked="" type="checkbox"/> Arm Support with Cushion	2pcs
<input checked="" type="checkbox"/> Anesthesia Screen Frame	1pc	<input checked="" type="checkbox"/> Stainless Steel Basin	1pc
<input checked="" type="checkbox"/> Hand Bars	2pcs		

A98-4

Electric Obstetric Bed



Technical Parameters

External Length	1920mm
External Width	920mm
Table Height Min.	650mm
Table Height Max.	900mm

Technical Configuration

<input checked="" type="checkbox"/> Mattress	1pc	<input checked="" type="checkbox"/> Slider	2pcs	<input checked="" type="checkbox"/> Castors	4pcs
<input checked="" type="checkbox"/> Handle	2pcs	<input checked="" type="checkbox"/> Tightener	2pcs	<input checked="" type="checkbox"/> Central Locking Pedal	2pcs
<input checked="" type="checkbox"/> Leg Support	2pcs	<input checked="" type="checkbox"/> Hand Controller	1pc		
<input checked="" type="checkbox"/> ABS Side Rail	2pcs	<input checked="" type="checkbox"/> Stainless Steel Basin	1pc		

A99-8

Electric Gynecological Exam Couch

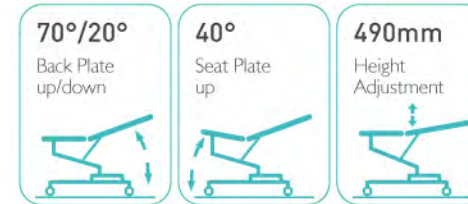

Technical Parameters

External Length	1400mm
External Width	740mm
Table Height Min.	610mm
Table Height Max.	1100mm

Technical Configuration

<input checked="" type="checkbox"/> Hand Bars	2pcs
<input checked="" type="checkbox"/> Leg Support with Cushion	2pcs
<input checked="" type="checkbox"/> Foot Pedal	1pc
<input checked="" type="checkbox"/> Stainless Steel Basin	1pc

A99-6

Electric Gynecological Exam Couch

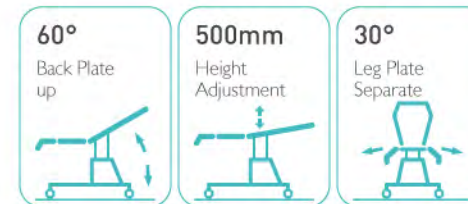

Technical Parameters

External Length	1200mm
External Width	500mm
Table Height Min.	500mm
Table Height Max.	1000mm

Technical Configuration

<input checked="" type="checkbox"/> Simple Side Rail	1set
<input checked="" type="checkbox"/> Leg Holder	1set
<input checked="" type="checkbox"/> 5" Castors 4	4pcs
<input checked="" type="checkbox"/> Foot Pedal	1pc



Optical System

The bulbs are imported from Germany OSRAM brand, using a special optical system, 360° uniformly illuminated on the observed object, no shadows, true reproduction of the organization color, and achieve constant color temperature under any light intensity conditions. The material is hard and no mercury pollution. Also, the emitted light does not contain infrared and ultraviolet radiation pollution.

Color Rendering Index

The color rendering index reaches 96, which truly reflects the color of human tissues. It is suitable for various surgical scenes and greatly reduces the visual fatigue of medical staff due to long-term operations.

Color Temperature&illumination

Using a new type of LED cold light source, the illuminance can reach 140000 Lux, which can realize 16-level brightness adjustment; the color temperature is in the range of 3500-5000K, and four-level color temperature adjustment can be achieved. While meeting the high illuminance, adjust the lighting parameters according to the needs of different surgeons, so that the surgeon's perception of light is soft and no glint.

OSRAM

CRI

≥96

Lux

140000

Kelvin

3500-5000

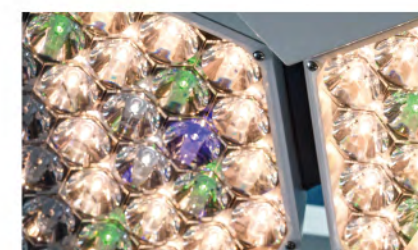

Lens

Each lens adopts a 40mm super large lens, and the lens arrangement is arranged according to the biology of insect compound eyes, and the mutual distance is less than 1mm, so that the shadowless effect is better.

Super Large Lens

40mm



Temperature Rise (Surgical Field)

LED cold light source has no infrared radiation, coupled with our nano-coated radiator, created our excellent heat dissipation effect. It solves the problem of the doctor's head temperature being too high during the operation, and creates a more comfortable operation environment for the doctor; it also effectively avoids the loss of water and infection of the surgical wound, which is conducive to the rapid recovery of the patient's wound after the operation.

Temperature Rise (Surgical Field)

≤1℃



Lighting Mode

With a variety of lighting modes, one-key switching, adapt to different clinical surgery scenes.

Lighting Mode

4

LUX series

LED
OPERATION
LAMP

LUX / series

LED Operation Lamp

The LED surgical shadowless lamp is composed of multiple lamp bulbs. The bulb has a longer life than the traditional shadowless lamp. It is round or petal-shaped. It is fixed on the balance arm suspension system. It is stable in positioning and can be moved vertically or cyclically. It can meet different heights during surgery.



The design of the lamp holder focuses on reducing the turbulence. The streamlined lampshade of the whole lamp arm is carefully designed according to the principle of aerodynamics, which is fully in line with the standard of a modern new operating room.

The coating is sprayed with world-leading Akzo Nobel powder coating and anti-glare treatment, which meets the demanding requirements of surgical lighting.

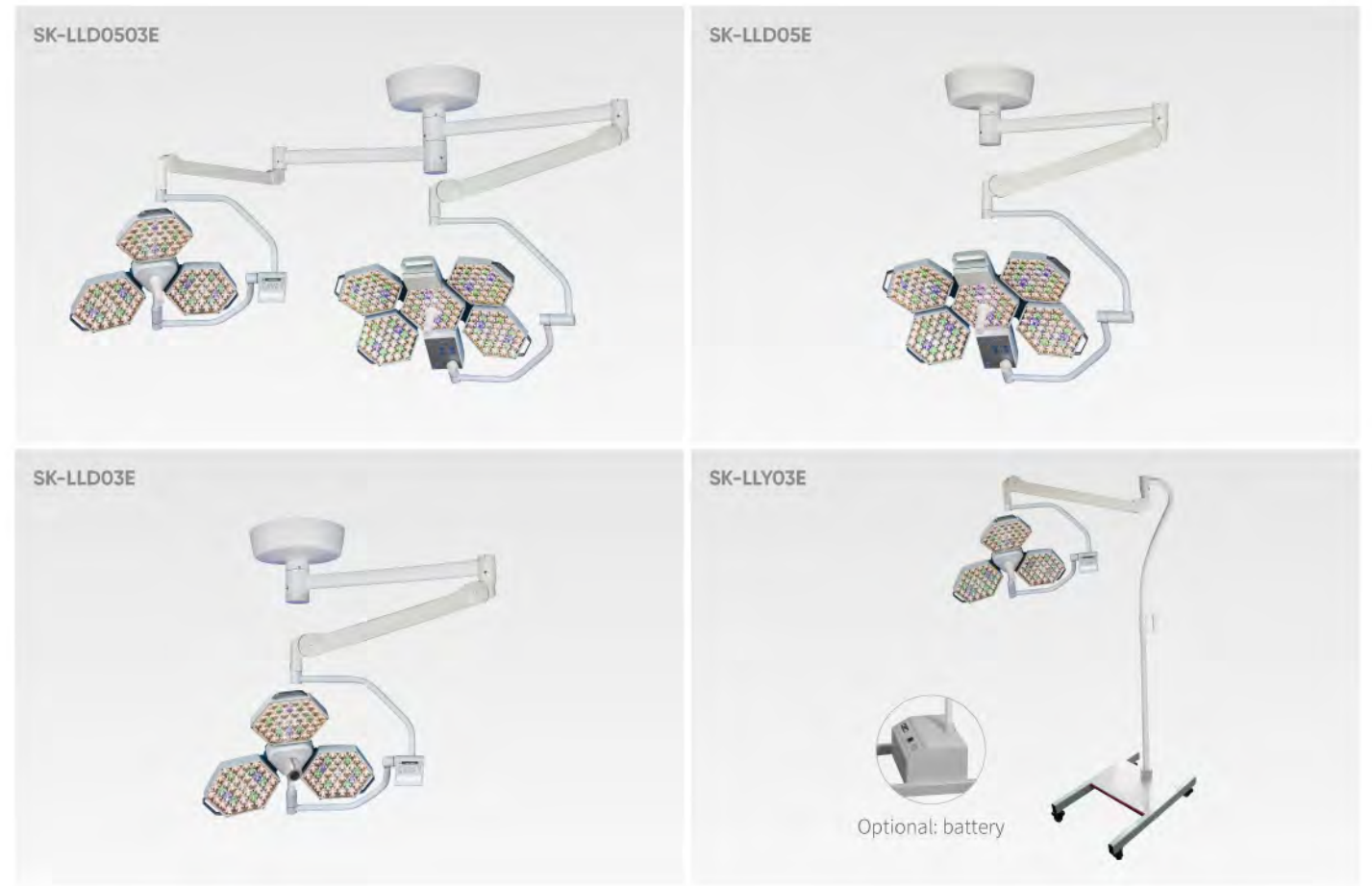
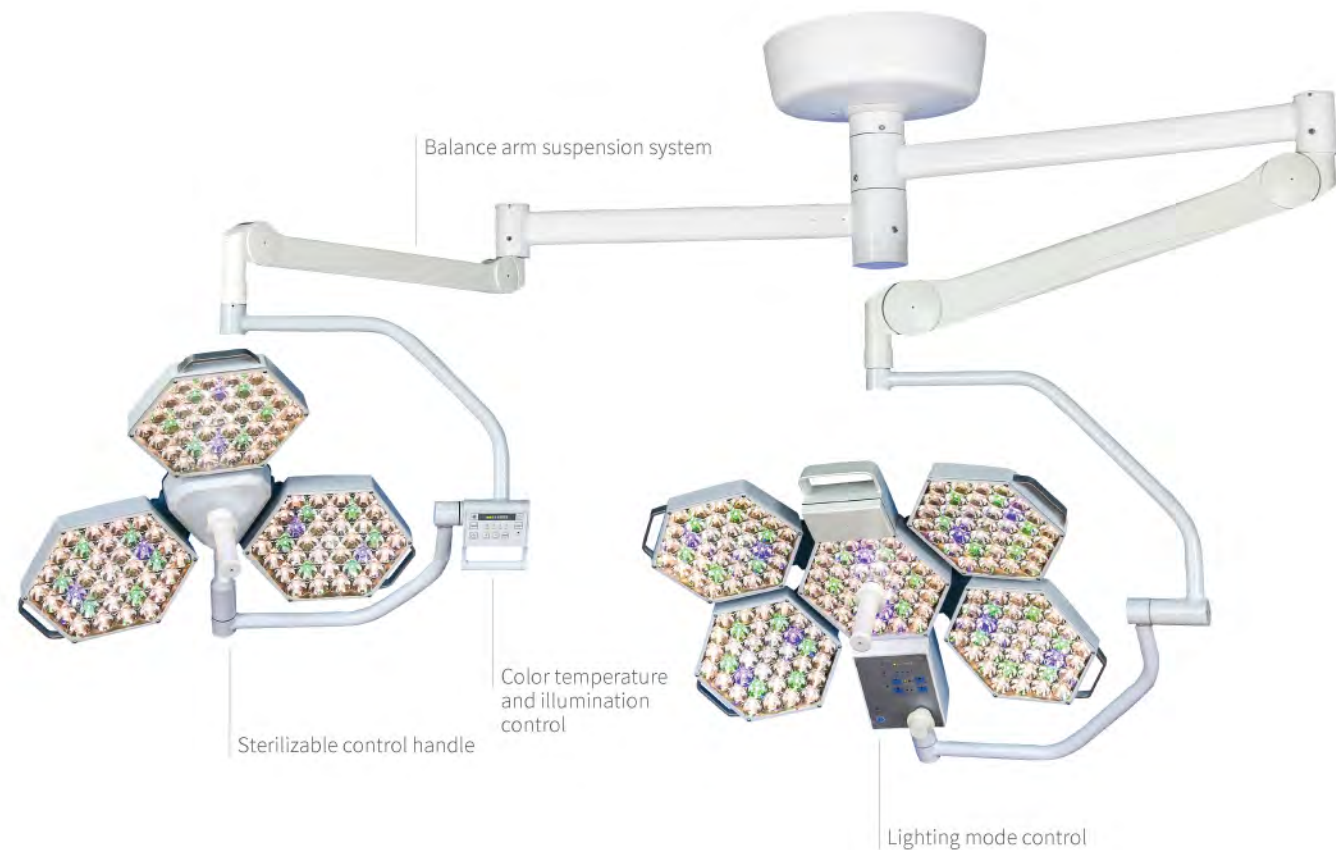

		SK-LLD0503E	SK-LLD05E	SK-LLD03E	SK-LLY03E
Diameter of lighthouse	mm	860/700	860	700	700
Illumination	Lux	140000/120000	140000	120000	120000
Color Temperature	Kelvin	3500-5000	3500-5000	3500-5000	3500-5000
Color Rendering Index(CRI)	Ra	≥96	≥96	≥96	≥96
Temperature rise(Surgeon head)	°C	≤3	≤3	≤2	≤2
Temperature rise(Surgical field)	°C	≤1	≤1	≤1	≤1
Effective Focusing Depth	cm	100	100	100	100
Lighting Spot Size	cm	22-31	22-31	22-31	22-31
L1+L2 depth of illumination	cm	100	100	100	100
Average Bulb Life	hours	≥50000	≥50000	≥50000	≥50000

Illumination/Lighting Spot Size: at 1m

LUX series

LED OPERATION LAMP

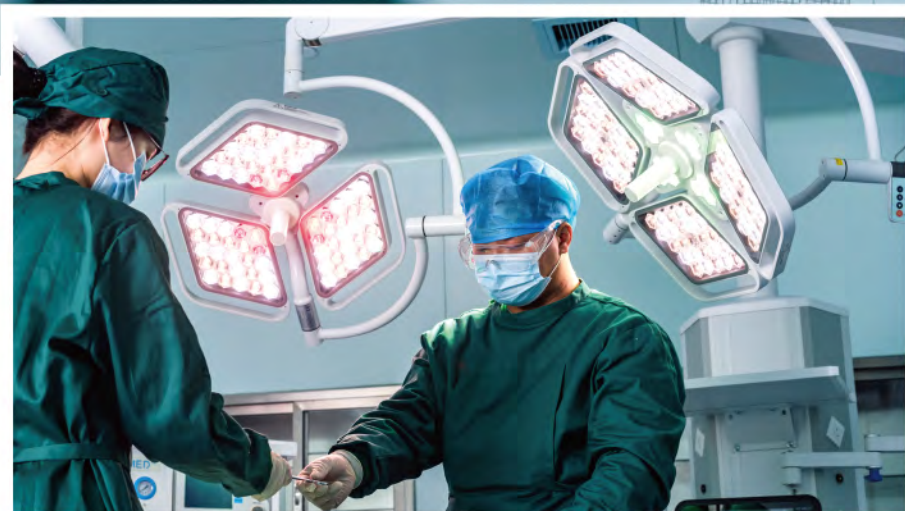

Superior Laminar Flow Applications

The streamlined hollow lamp body design reduces the area of the lamp cap that blocks the flow of purified air, thus reducing the air turbulence under the lamp that affects purification.



Green Light Mode

Applicable for surgery requiring high color rendering index, used for cardiothoracic surgery, neurosurgery, etc. Green light can reduce the flare caused by strong light on the eyes.



Special Overhaul Unit

Photoelectric separation design, is for quick repair, which keeps the circuit board away from the heat source. What's more, it increases the service life, and improve the convenience at the same time. The control box can also be easily disassembled for maintenance. The modular lamp body is made of high-quality aluminum alloy precision casting, and the light source can be replaced independently.

One-click Low Light (Endoscope) 3000lux

The operating light is equipped with a one-button low-light (endoscope) illumination mode, which allows the surgeon to quickly switch from regular illumination mode. Provides soft lighting to the environment without interfering with the surgeon's field of view and tissue viewing during the surgical procedure.

Low Light Mode
3000 Lux

Bright
16 Level

Lux
160000

Light Mode
4

Kelvin
3500-5000

High-density Light Mixing System

Using the original high-density light mixing technology, it not only provides ultra-high brightness, but also has high light quality, 16-level brightness adjustment, illuminance 40000-160000Lux, 4-level color temperature adjustment 3500K-5000K, 16-level electric spot size adjustment, Another cavity mirror, red light compensation, green light mode (GL) shadow compensation.

LUX / series

LED Operation Lamp

The LED surgical shadowless lamp is composed of multiple lamp bulbs. The bulb has a longer life than the traditional shadowless lamp. It is round or petal-shaped. It is fixed on the balance arm suspension system. It is stable in positioning and can be moved vertically or cyclically. It can meet different heights during surgery.



The design of the lamp holder focuses on reducing the turbulence. The streamlined lampshade of the whole lamp arm is carefully designed according to the principle of aerodynamics, which is fully in line with the standard of a modern new operating room.

The coating is sprayed with world-leading Akzo Nobel powder coating and anti-glare treatment, which meets the demanding requirements of surgical lighting.

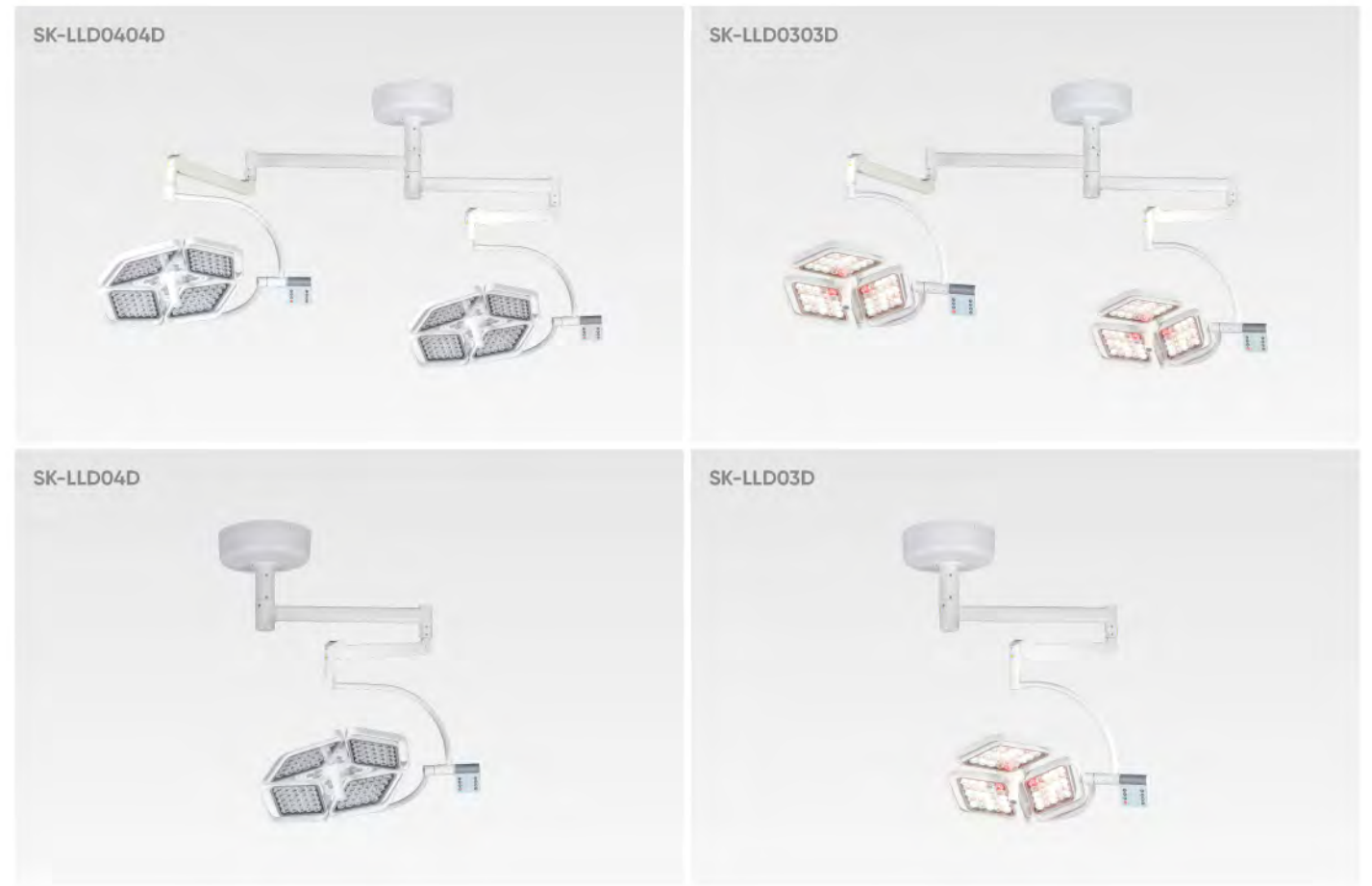
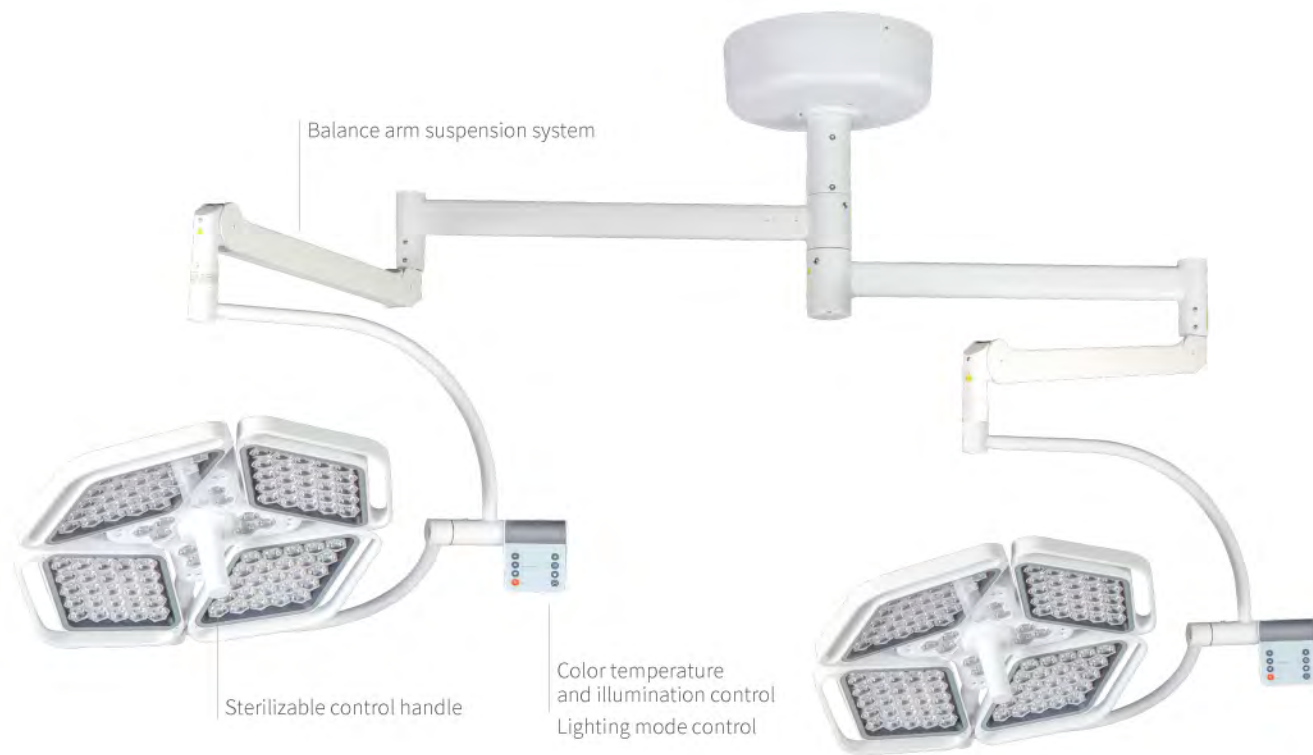

		SK-LLD0404D	SK-LLD0303D	SK-LLD04D	SK-LLD03D
Diameter of lighthouse	mm	700/700	615/615	700	615
Illumination	Lux	160000/160000	140000/140000	160000	140000
Color Temperature	Kelvin	3500-5000	3500-5000	3500-5000	3500-5000
Color Rendering Index(CRI)	Ra	≥96	≥96	≥96	≥96
Temperature rise(Surgeon head)	°C	≤2	≤2	≤2	≤2
Temperature rise(Surgical field)	°C	≤1	≤1	≤1	≤1
Effective Focusing Depth	cm	100	100	100	100
Lighting Spot Size	cm	10-25	10-25	10-25	10-25
L1+L2 depth of illumination	cm	100	100	100	100
Average Bulb Life	hours	≥50000	≥50000	≥50000	≥50000

Illumination/Lighting Spot Size: at 1m



IXUS series
LED
OPERATION
LAMP



		SK-LLD7272C	SK-LLD7252C	SK-LLD72C	SK-LLD52C	SK-LLY72C	SK-LLY52C
Diameter of lighthead	mm	720/720	720/520	720	520	720	520
Illumination	Lux	160000/160000	160000/160000	160000	160000	160000	160000
Color Temperature	Kelvin	3000-6700	3000-6700	3000-6700	3000-6700	3000-6700	3000-6700
Color Rendering Index(CRI)	Ra	≥98	≥98	≥98	≥98	≥98	≥98
Temperature rise(Surgeon head)	°C	≤1	≤1	≤1	≤1	≤1	≤1
Temperature rise(Surgical field)	°C	≤2	≤2	≤2	≤2	≤2	≤2
Effective Focusing Depth	cm	130	130	130	110	130	110
Lighting Spot Size	cm	10-35	10-35	10-35	10-35	10-35	10-35
L1+L2 depth of illumination	cm	100	100	100	100	100	100
Average Bulb Life	hours	≥60000	≥60000	≥60000	≥60000	≥60000	≥60000

Illumination/Lighting Spot Size: at 1m



WILLYS/series

LED OPERATION LAMP

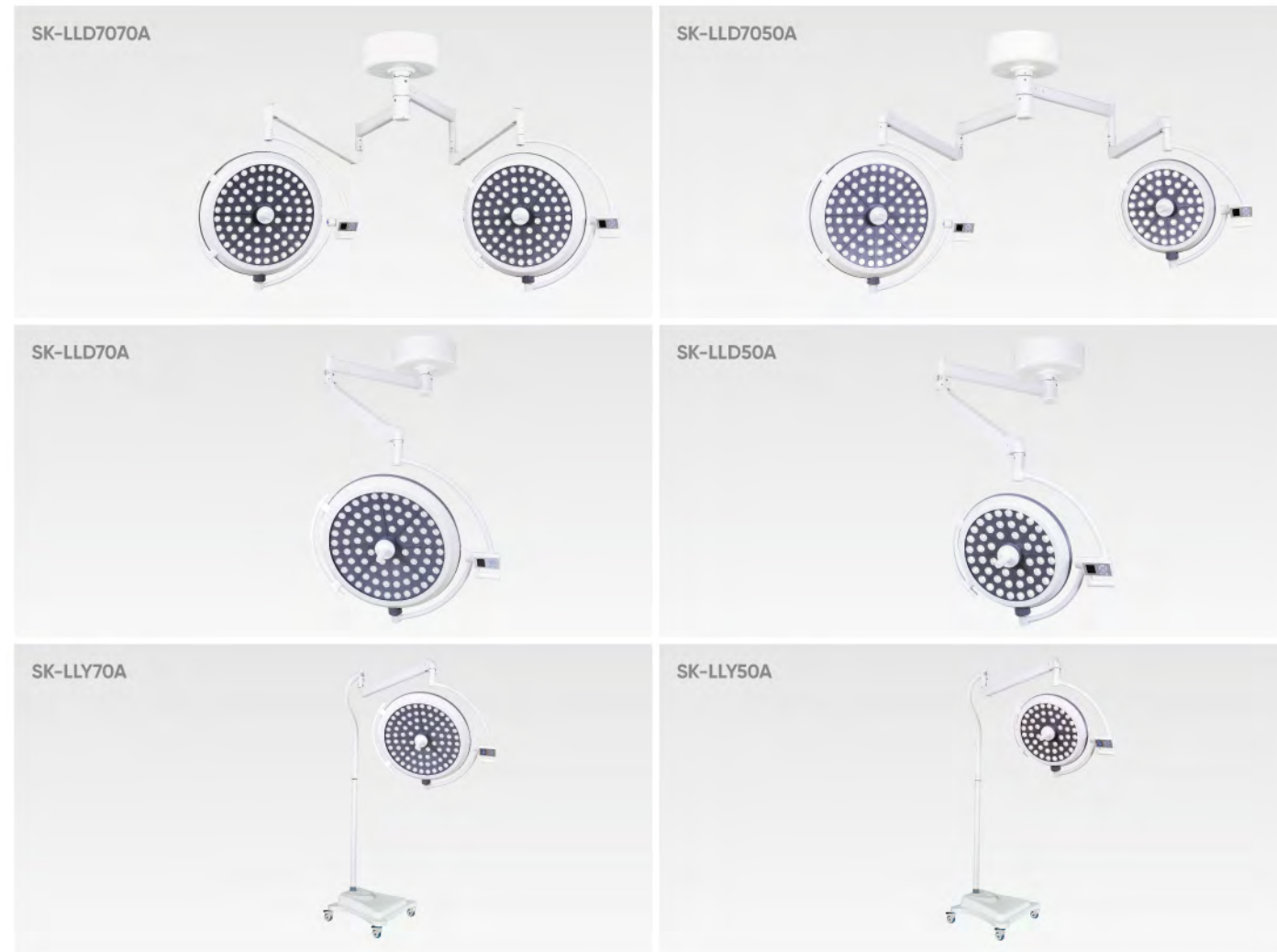

		SK-LLD7070A	SK-LLD7050A	SK-LLD70A	SK-LLD50A	SK-LLY70A	SK-LLY50A
Diameter of lighthead	mm	700/700	700/500	700	500	700	500
Illumination	Lux	180000/180000	180000/160000	180000	160000	180000	160000
Color Temperature	Kelvin	3700-5000	3700-5000	3700-5000	3700-5000	3700-5000	3700-5000
Color Rendering Index(CRI)	Ra	85-95	85-95	85-95	85-95	85-95	85-95
Temperature rise(Surgeon head)	°C	≤1	≤1	≤1	≤1	≤1	≤1
Temperature rise(Surgical field)	°C	≤1	≤1	≤1	≤1	≤1	≤1
Effective Focusing Depth	cm	60-130	60-130	60-130	60-130	60-130	60-130
Lighting Spot Size	cm	16-28	16-28	16-28	16-28	16-28	16-28
L1+L2 depth of illumination	cm	130	130	130	130	130	130
Average Bulb Life	hours	≥80000	≥80000	≥80000	≥80000	≥80000	≥80000

Illumination/Lighting Spot Size: at 1m



IXUS series

LED
OPERATION
LAMP



		SK-LLD0505C	SK-LLD05C	SK-LLY05C	SK-LLY03C
Diameter of lighthouse	mm	650/650	650	650	650
Illumination	Lux	180000/180000	180000	180000	160000
Color Temperature	Kelvin	4000-6000	4000-6000	4000-6000	4000-6000
Color Rendering Index(CRI)	Ra	85-95	85-95	85-95	85-95
Temperature rise(Surgeon head)	°C	≤1	≤1	≤1	≤1
Temperature rise(Surgical field)	°C	≤1	≤1	≤1	≤1
Effective Focusing Depth	cm	60-130	60-130	60-130	60-130
Lighting Spot Size	cm	16-28	16-28	16-28	16-28
L1+L2 depth of illumination	cm	≥130	≥130	≥130	≥130
Average Bulb Life	hours	≥80000	≥80000	≥80000	≥80000

Illumination/Lighting Spot Size: at 1m

WILLYS / series

LED Operation Lamp



		SK-LLD0404B	SK-LLD04B	SK-LLY04B
Diameter of lighthouse	mm	675/675	675	675
Illumination	Lux	160000/160000	160000	160000
Color Temperature	Kelvin	3000-6700	3000-6700	3000-6700
Color Rendering Index(CRI)	Ra	≥97	≥97	≥97
Temperature rise(Surgeon head)	°C	≤1	≤1	≤1
Temperature rise(Surgical field)	°C	≤2	≤2	≤2
Effective Focusing Depth	cm	130	130	130
Lighting Spot Size	cm	10-30	10-30	10-30
L1+L2 depth of illumination	cm	≥120	≥120	≥120
Average Bulb Life	hours	≥60000	≥60000	≥60000

Illumination/Lighting Spot Size: at 1m

VOLTH / series

Integral Reflection Operation Lamp



		SK-LZD7070A	SK-LZD7050A	SK-LZD70A	SK-LZD50A	SK-LZY70A	SK-LZY50A
Diameter of lighthouse	mm	700/700	700/500	700	500	700	500
Illumination	Lux	180000/180000	180000/160000	180000	160000	180000	160000
Color Temperature	Kelvin	4500±250	4500±250	4500±250	4500±250	4500±250	4500±250
Color Rendering Index(CRI)	Ra	≥85	≥85	≥85	≥85	≥85	≥85
Temperature rise(Surgeon head)	°C	≤1	≤1	≤1	≤1	≤1	≤1
Temperature rise(Surgical field)	°C	≤1	≤1	≤1	≤1	≤1	≤1
Effective Focusing Depth	cm	60-120	60-120	60-120	60-120	60-120	60-120
Lighting Spot Size	cm	16-28	16-28	16-28	16-28	16-28	16-28
L1+L2 depth of illumination	cm	≥120	≥120	≥120	≥120	≥120	≥120
Average Bulb Life	hours	≥1500	≥1500	≥1500	≥1500	≥1500	≥1500

Illumination/Lighting Spot Size: at 1m

MEDICAL
BRIDGE
CEILING
PENDANT



SK-PQ003

Combined Medical Bridge Ceiling Pendant

The combined medical bridge ceiling pendant is suitable for compact rooms, two or more modules of medical bridge ceiling pendant can be connected from head to end, improving the space utilization of ICU room, saving treatment space as much as possible without all configurations changed.

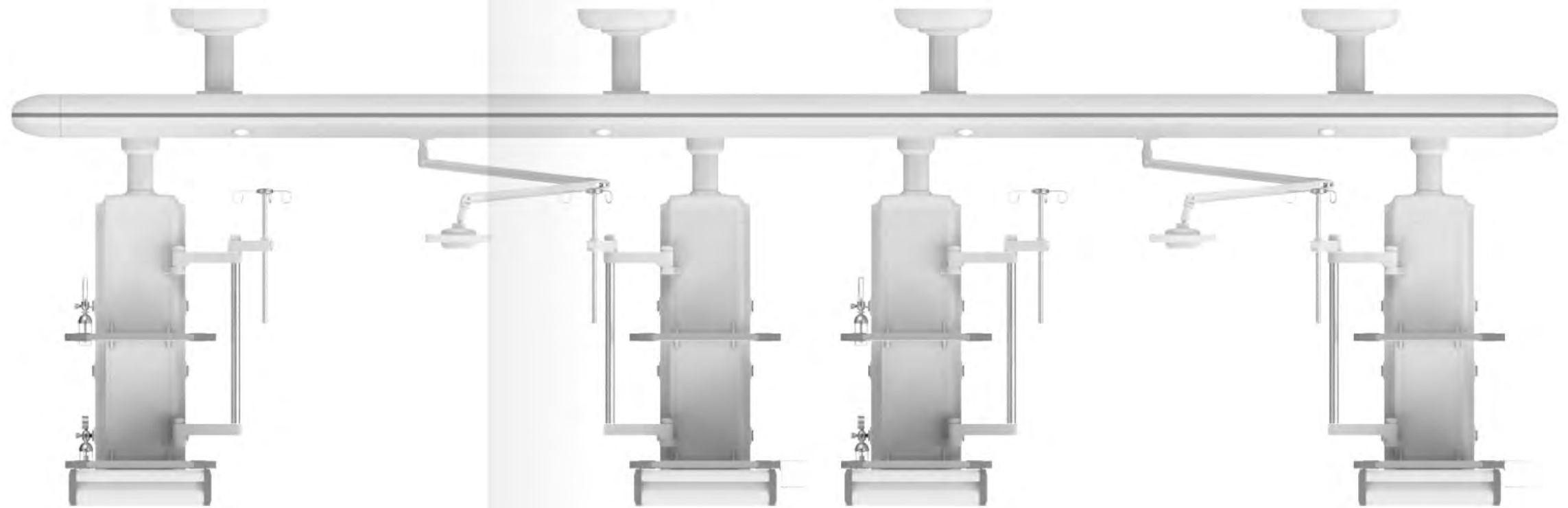

SK-PQ001

Medical Bridge Ceiling Pendant (separate wet and dry areas)

The ICU medical bridge ceiling pendant (separate wet and dry areas) is a medical rescue auxiliary equipment;

Features:

1. There are multi-layer instrument platforms in wet (gas) and dry (electric) areas;
2. The height of drawers can be adjusted;
3. With retractable IV pole, with four hooks;
4. The function columns and cabinets built in rotation limit device to prevent the drift;

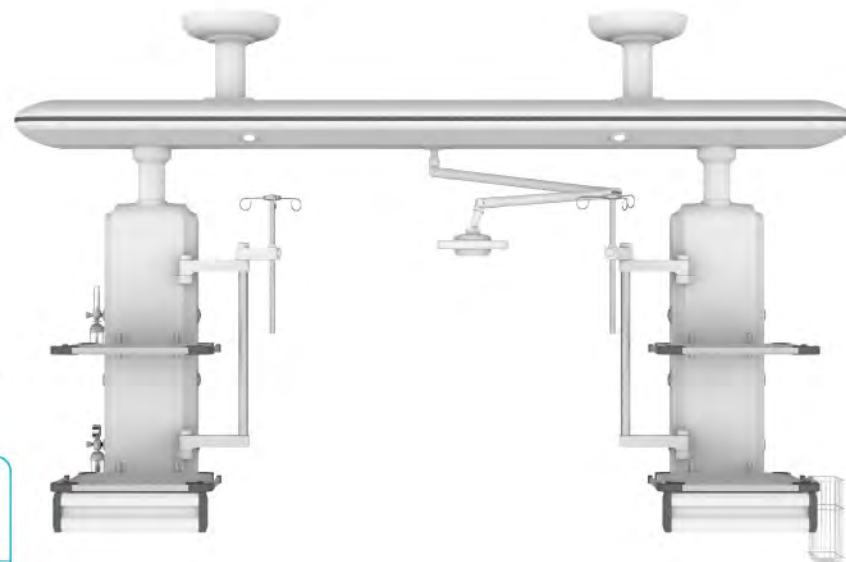

SK-PQ002

Medical Bridge Ceiling Pendant (Integration of dry and wet areas)

The medical bridge ceiling pendant (Integration of dry and wet areas) is based on the separation of dry and wet, the two areas are combined into one, suitable for NICU and small nursing areas.

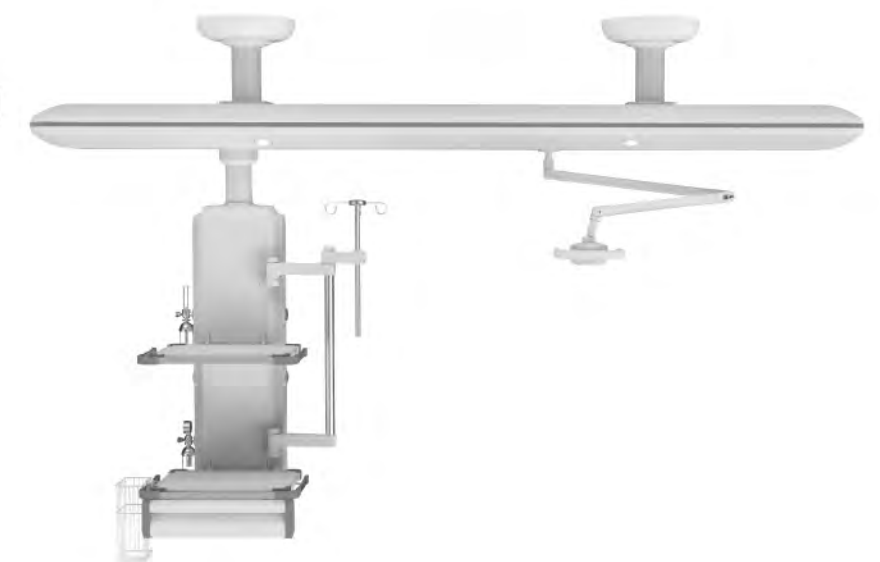

SK-PQ004

Multi-arm Medical Ceiling Pendant

The multi-arm combined medical bridge ceiling pendant is suitable for compact ICU rooms, the combination of flexible arms and function columns can make full use of the space of the ICU rooms.

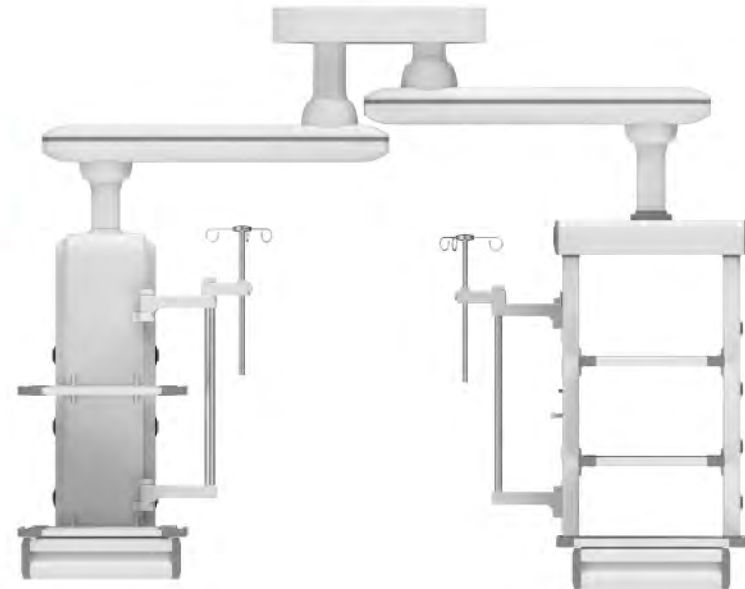

SK-PT001

Single Arm Medical Bridge Ceiling Pendant

The single arm medical bridge ceiling pendant, meeting the daily load-bearing requirements and using strong material, made of imported antibacterial plastic powder, ensuring the cleanliness of the operating environment. Its rich accessories matching various systems, greatly extending the clinical practicability.



SK-PQ005

Multi-arm Medical Ceiling Pendant

The multi-arm combined medical bridge ceiling pendant is suitable for compact ICU rooms, the combination of flexible arms and function columns can make full use of the space of the ICU rooms.

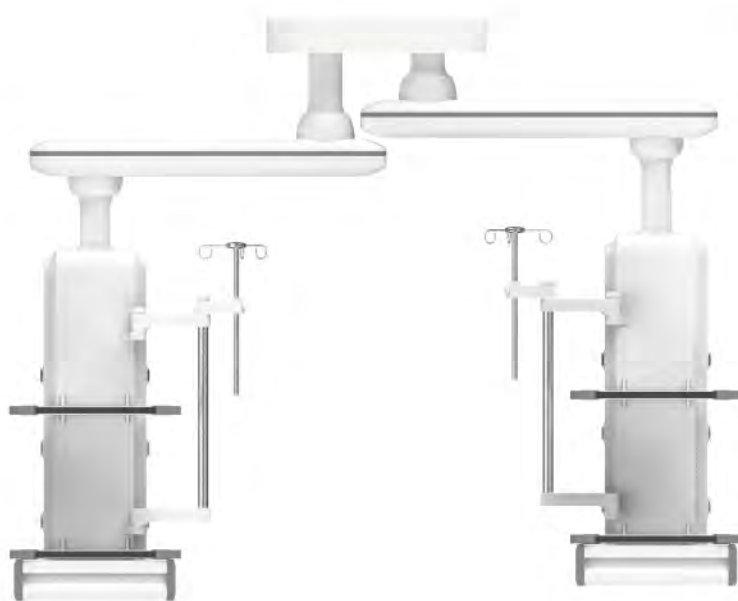

SK-PT002

Single Arm Medical Endoscopic Bridge Ceiling Pendant

The single arm medical endoscopic bridge ceiling pendant is endoscopy surgery auxiliary equipment, meeting the daily load-bearing requirements and using strong material, made of imported antibacterial plastic powder, ensuring the cleanliness of the operating environment. Its rich accessories matching various systems, greatly extending the clinical practicability.



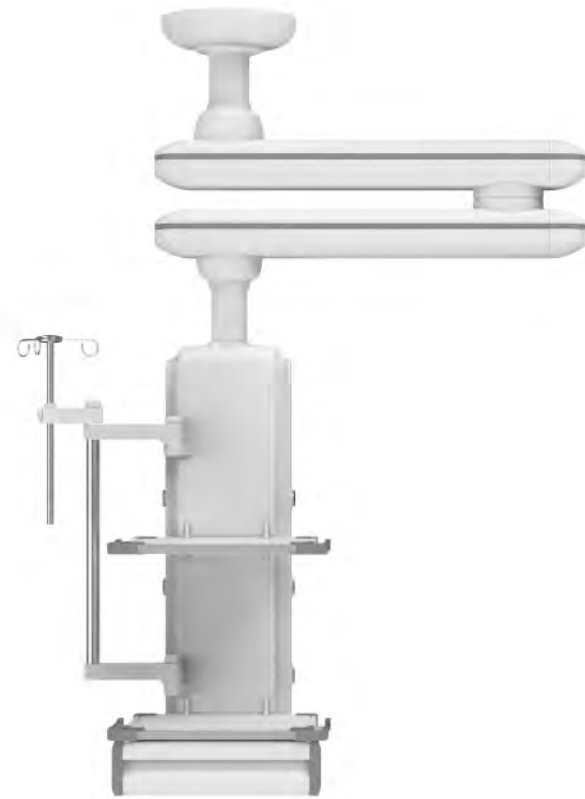

SK-PT003 Double Arms Medical Bridge Ceiling Pendant

The double arms medical bridge ceiling pendant is more flexible in moving and positioning, compared with the single one, longer treatment coverage radius, meeting the daily load-bearing requirements and using strong material, made of imported antibacterial plastic powder, ensuring the cleanliness of the operating environment. Its rich accessories matching various systems, greatly extending the clinical practicability.



SK-PT004 Mobile Medical Bridge Ceiling Pendant

The mobile medical bridge ceiling pendant can be connected with external power supply and medical air source, bearing 200kg, prevent the shortages of gas electricity supply when adding nursing machines.



SK-PT005 Anesthesia Medical Bridge Ceiling Pendant

The anesthesia medical bridge ceiling pendant is equipped with hanging holder for anesthesia machine, bearing 250 kg of anesthesia machine, with international AGSS jet exhaust gas, suitable for anesthesia surgery.



SK-PT006 Supply Column

Working table supports can be placed on both sides of the supply column, one-stop operation for medical staff, suitable for supply rooms.



SK-PT008 Medical Bridge Ceiling Pendant For Imaging Operating Room

The medical medical bridge ceiling pendant for imaging operating room is a basic equipment specially designed for endoscopic treatment. Used for carrying instrument of endoscope, monitor and so on. Providing air pump, power supply, video and communication interfaces for equipment, with cable and pipeline, making the operating environment orderly.

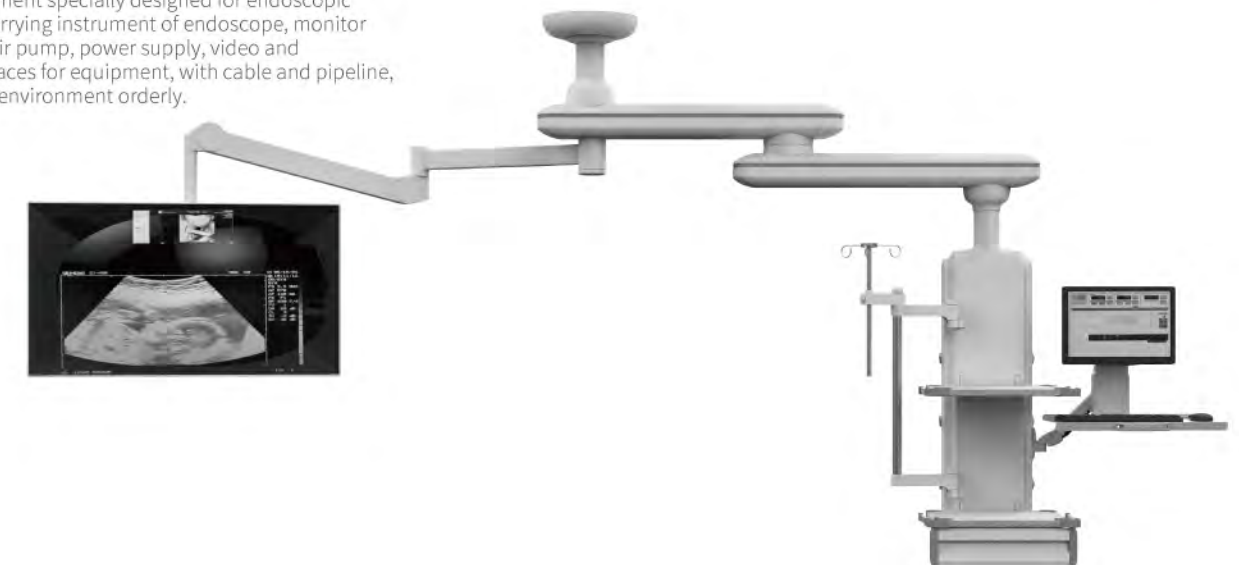

ACCESSORIES

Operating Table Accessories

Floor Type Multi-functional Orthopedic Frame



Connecting Multi-functional Orthopedic Frame



Carbon Fiber Multi-functional Orthopedic Frame



Multi-purpose Head Rack



Shoulder Traction Frame



Mechanical Power IV Pole



Stirrup Pneumatic Power Leg Rack



Bow Spine Operating Supporter



Operating Table Accessories Cart



Knee surgery rack



Double table top



Prone body supporting frame



Shoulder surgery rack



Arm microsurgical rack



Bed surface widening module



External kidney bridge



Dirt basin



Body safe strap



ACCESSORIES

Gel Mattress Position Solution

Supine Position



Prone Position



Prone Position

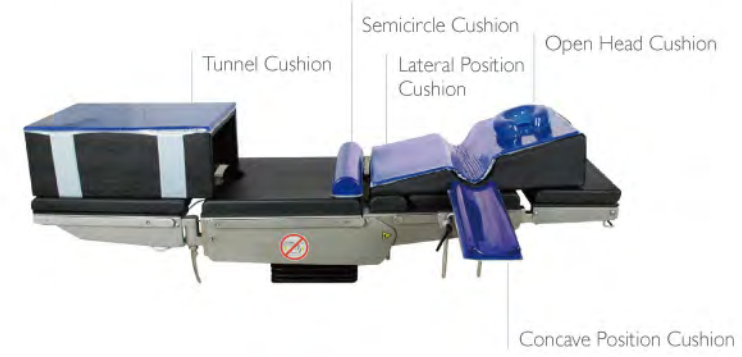

Cut Stone Position



Medical Bridge Ceiling Pendant Accessories

Disposable Oxygen Inhaler B



Disposable Oxygen Inhaler A



Disposable Oxygen Inhaler (Simple Type)



External Hanging Oxygen Inhaler



External Hanging Waste Liquid Collection Device



Oxygen Inhaler (All Metal)



Waste Liquid Collection Device



Negative Pressure Regulating Valve



Standard Medical Terminals



Interface Medical Terminal



AGSS Jet Exhaust Device



Terminal Plug

