



A501

ELECTRIC-HYDRAULIC OPERATING TABLE

Registration code: SKT-B



SKSurgitech™
by Saikang Medical

Care you precisely

A501

FEATURES AND HIGHLIGHTS



Technical parameters

External size (LxWxH):	2125x550x(600-950)mm
Reverse trendelenburg:	0-20°
Trendelenburg:	0-15°
Lateral tilt left/right:	0-15°
Head plate up/down:	55°/90°
Back plate up/down:	89°/35°
Leg plate up/down:	15°/90°
Leg plate outwards:	90°
Kidney bridge elevation:	0-120mm
Horizontal sliding:	0-320mm
Horizontal rotation:	180°

Technical configuration

<input checked="" type="checkbox"/> Bed frame	1pc
<input checked="" type="checkbox"/> Mattress	1set
<input checked="" type="checkbox"/> Anesthesia screen frame	1pc
<input checked="" type="checkbox"/> Shoulder holder with cushion	2pcs
<input checked="" type="checkbox"/> Arm holder with cushion	2pcs
<input checked="" type="checkbox"/> Leg support with cushion	2pcs
<input checked="" type="checkbox"/> Foot support with cushion	2pcs
<input checked="" type="checkbox"/> Hand controller	1pc
<input checked="" type="checkbox"/> Kidney bridge handle	1pc
<input checked="" type="checkbox"/> Battery back-up	1pc

Material

The base column and side hoder are all made of high quality 304 stainless steel, which is anti-corrosive and can be easily cleaned.



Dual control system

All functions controlled by both hand controller or control panel on table base column. With action LCD display on hand controller, easy to operate. With control panel on table base column, in case of emergency hand controller failure.

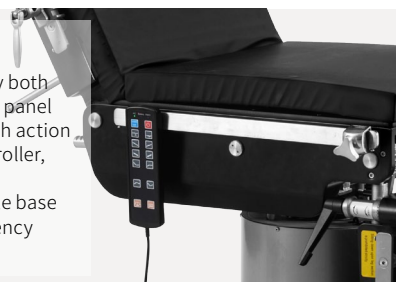

Special functions

With table top 180° rotation function.



Battery back-up

Equipped with a built-in emergency power supply, the emergency power supply can be automatically charged, and the emergency power supply can automatically jump to the working state when the network power supply is cut off.

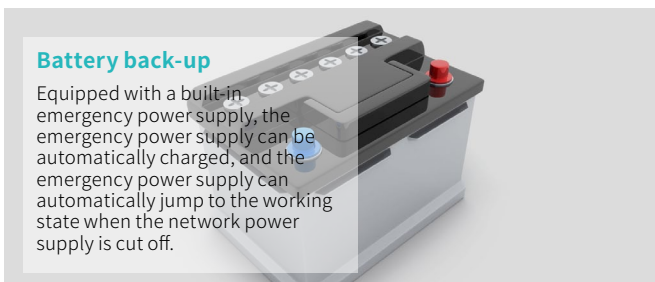

Brake

Electric Control system for the brake, it is easily for moving operating table.

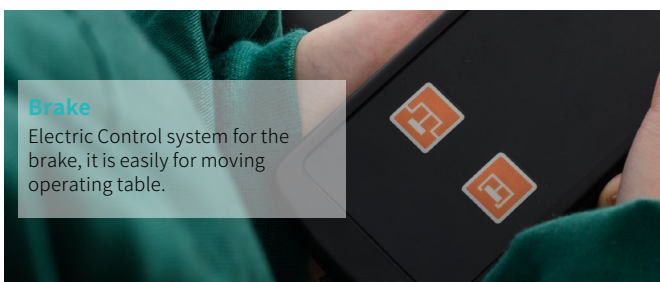

Kidney bridge

Built-In Kidney Bridge, More Convenient And Nice Appearance.

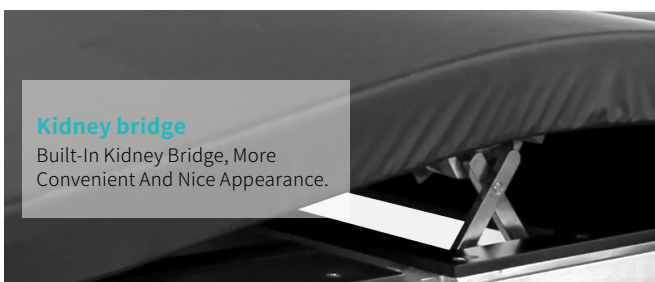

Mattress

PU cover, memory mattress, easy cleaning, thickness of mattress: 5cm.

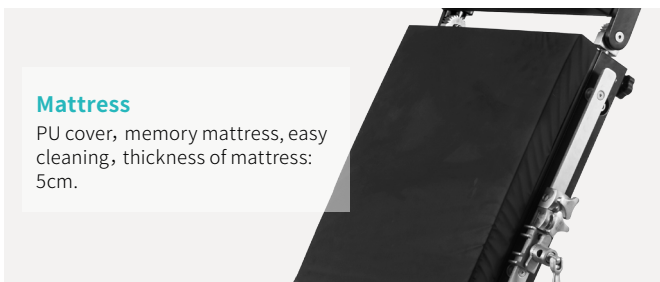

Anesthesia screen frame



**Leg support with cushion
Foot support with cushion**



Arm holder with cushion



Shoulder holder with cushion

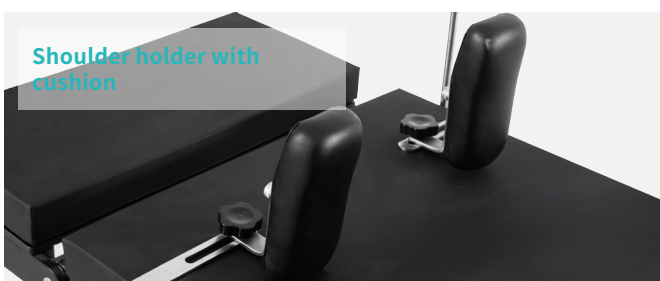

Body holder with cushion

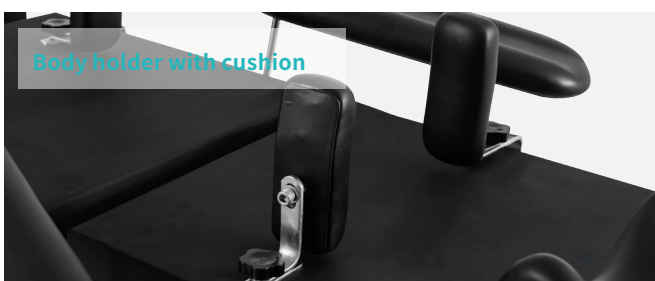

Professional functions

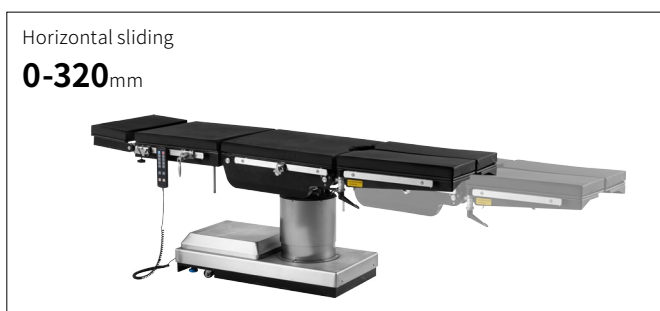
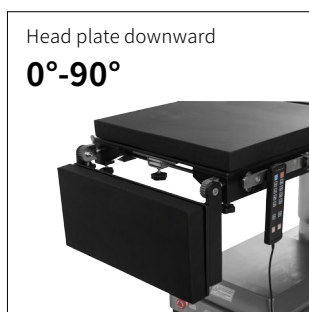



CONSTANT INNOVATION

Design

Research

Manufacturing

Maintenance

Service



WORLDWIDE BRANCHES

South America Branch

Saikang Medical Technology, Inc

W3400 Corrientes, Argentina
TEL: +55 (11) 2758-0438
Rua Universal, Hollywood,
São Bernardo do Campo,
Brazil
TEL: +55 (11) 2758-0438

East Africa Branch

Saikang Medical Technology Ltd

Mezzanine Floor, Taj Tower,
upper hill, nairobi, Kenya
TEL: +254714084806

South East Asia Branch

Saikang Medical Technology Ltd

Sala Thammasop Subdistrict
Thawi
Watthana District
Bangkok Thailand
TEL: +66 642741046

UK Branch

Uk Healthward International Limited

DEPT 111,
196 High Road Wood Green,
London, N22 8HH
United Kingdom
TEL: +31 (0) 2021111106

Russia Branch

LLC 'SAIKANG'

454004, Russian Federation,
Chelyabinsk,
Universitetskaya Naberezhnaya,
Russia
TEL: +7 (919)300-00-06

Mid East Branch

Saikang Medical Supplies (Mid East) LLC

Musaffah
P.O Box 53200, Abu Dhabi,
UAE
Tel: +971 585710652

SKSurgitech™

by Saikang Medical

Jiangsu Saikang Medical Equipment Co., Ltd.
STOCK CODE: 870098

📍 No. 35, Lehong Road · Zhangjiagang (Jiangsu) · China

☎ +86 18021231901 · 🗨 24/7

✉ export@sksurgitech.com

🌐 www.sksurgitech.com



Company video



General catalogue